



NANOWAVE
Technologies Inc.

Thin-Film Products

NANOWAVE Technologies Inc.

CONTENT

Thin Film Technology Services	2
Qualifications	2
Thin Film Substrates	3
Thin Film Design Guidelines	4
MHMIc (Miniature Hybrid Microwave IC)	5
Hermetic SMD Packages	6
Single Layer Ceramic (SLC) Capacitors	7
High Value Chip Capacitors	10
Microwave Chip Resistor	11
Broadband Medium Power Thin Film Attenuator	13
Thin Film Filters	15
About NANOWAVE	16

THIN FILM TECHNOLOGY SERVICES

The Thin-Film Division at NANOWAVE Technologies Inc. manufactures microwave thin film circuits and RF passive components to serve the Aerospace, Defense, Communications, Industrial and Medical industries.

The thin film facility houses more than 5000 sq-ft class 100 to class 10,000 clean room area. Thin film coating equipment includes 3-target sputtering systems, E-beam evaporation systems, and a CVD system, delivering a variety of reliable metallizations for conductor, barrier, resistor, and dielectric films. In addition to standard photo-patterning and etching, ion-beam milling and e-beam evaporation/lift-off lithography capabilities offer patterning to 10 micron \pm 3.0 micron precision.

Products include custom-designed thin film circuits consisting of sputtered and electroplated gold and thick copper conductors, metalized or hermetic filled via holes, sheet resistors, nickel barrier layers, and complex shaped substrates in a wide choice of ceramics and dielectric materials. MHMICs (Miniature-Hybrid-Microwave Integrated Circuits) integrate the passive circuitry typically found on GaAs MMICs, such as thin film resistors, air-bridges, overlay capacitors, and spiral inductors, on less expensive alumina or Aluminum Nitride substrates reducing cost and development time.

NANOWAVE Technologies Thin Film Division also manufactures a series of Passive components including broadband Attenuators, Microwave chip Resistors and MIS (Metal-Insulator-Silicon) chip capacitors for RF applications.

QUALIFICATIONS

All the products are fully qualified and tested to meet or exceed the requirements of MIL-STD-883, MIL-STD-202, and MIL-C-49464 for capacitors.

NANOWAVE Technologies Inc. is fully ISO9001:2008 and AS9100C certified.



THIN FILM SUBSTRATES

ALUMINUM OXIDE SUBSTRATES

Aluminum Oxide offers excellent RF characteristics for frequencies up to 100 GHz. It is a very low loss material, and has excellent bonding capability. Via holes can be plated or filled

- Material: 99.6 % Al_2O_3 as fired or polished
- Size: up to 4" x 4"
- Substrate Thickness: 0.005", 0.010", 0.015", 0.025" 0.040"
- Critical Dimensions: 15 μm (lines) and 12 μm (spaces)
- Metal layer thickness: 5 μm +/- 2 μm
- Conductor Metal Au
- Diffusion barrier: Ni

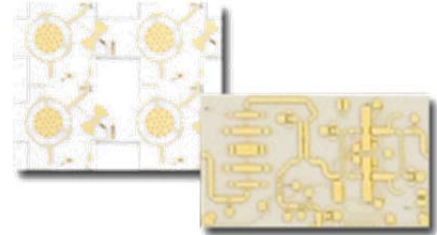

ALUMINUM NITRIDE SUBSTRATES

Typical applications for AlN substrate material are Laser Sub-mounts and other high power applications. The material offers low RF loss, and very good thermal conductivity for mounting as a heat spreader.

- Material: AlN
- Size: up to 4" x 4"
- Substrate Thickness: 0.010", 0.015", 0.025" 0.040 in.
- Critical Dimensions: 15 μm (lines) and 12 μm (spaces)
- Metal layer thickness: 5 μm +/- 2 μm
- Conductor Metal Au
- Diffusion barrier: Ni

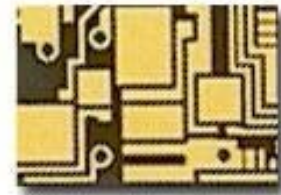

THICK COPPER TECHNOLOGY

Thick Copper Technology is used whenever high supply currents occur and/or high heat dissipation is required. The copper layers offer very low losses.

- Substrate material: Al_2O_3 , AlN, BariumTitanate
- Size: up to 7,65" x 5,15"
- Substrate Thickness: 0.015", 0.050"
- Critical Dimension: 75 μm (lines & spaces)
- Cu layer thickness: 75 μm
- Cap metals: Ni / Au (excellent bond ability)
- Solder Mask: optional (c.f. green layer on photograph)

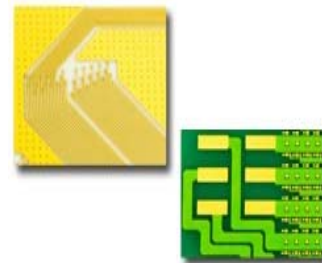

THIN FILM DESIGN GUIDELINES

Fig. 1: Sample Substrate Design

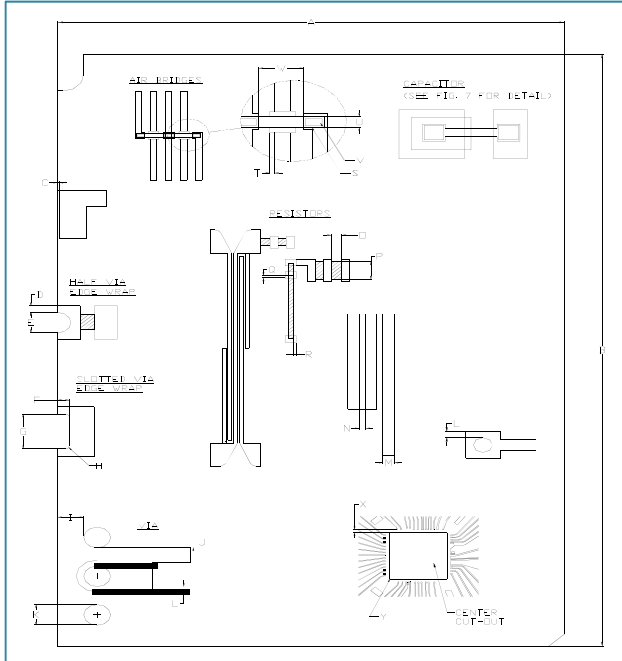

Table 1: Substrate Material

Material	Alumina (96.5%, 99.6%); Aluminum Nitride (K=170 W/m ² K); Quartz; (Ba)TiOxide, (ZrSn)TiOxide (Er=37-39)
Wafer Size (inches)	1x1, 2.25x2.25, 4x4 (Note: Only 1x1 can be used for 5 mil thick material.)
Thickness (mils)	5, 10, 15, 20, 25 (Note: Only 15 mil or thicker material can be processed in 4x4 in. panel).
Surface finish (micro-inches)	<1 μ-inches for alumina; <2 μ-inches for AlN

Table 2: Metallization Specification

Conductor layer	Gold Typical 3 – 5 micron. Resistivity <10mΩ/sq. Current carry capacity : 20mA/micron of trace width on alumina Copper Typical 5 – 75 micron
Adhesion layer	TiW 300 – 500A°
Resistive layer	Tantalum Nitride (TaN) 10, 25, 50, 100 Ω/sq. TCR -150+/-50ppm/°C. Power Handling: 250W/in ² on Alumina or 1000W/in ² on AlN
Barrier layer	Nickel (if thin film is solder mounted with AuSn or AuGe). 1500-2000A°
Air bridge	Gold 3 - 5 micron. Resistivity < 10mΩ/sq. Current carry capacity : 20mA/micron of line width.
Polyimide Dielectric	Thickness Typical 7 +/- 1 micron

Table 3: Features and Dimension Specifications (Refer to Fig. 1)

Ref	Feature	Spec
A/B	Circuit Size (tolerance : +/- 0.002")	3.75" x 3.75" (max)
C	Metal Pull Back from substrate edge (Front or Back)	0.002" (min)
Edge Wraparounds:		
D	Pad size from edge of via hole or cut out or castellation	0.003" (min)
E	Size of half via edge wrap	70% material thickness or 0.010" min.
F	Edge slot (castellation) depth	0.002" min.
G	Edge slot width	0.020" min., 0.050" max.
H	Edge slot radius	0.004" min.
Via Holes: (Placement tolerance : +/- 0.002")		
I	Spacing from via edge to substrate edge	0.010" min. or 1x material thickness.
J	Via to via spacing (edge to edge)	0.010" min. or 1x material thickness.
K	Plated Via diameter (tolerance: +/- 0.002")	0.005" min. or 50% of material thickness.
L	Pad size around via	0.003" min.
Conductor:		
M/N	Width / Spacing (tolerance: +/- 0.0001") Front to Back pattern registration	0.001" min./ 0.0004" min. +/- 0.001"
Resistor:		
O	Minimum Length	0.002"
P	Minimum Width	0.002"
Q	Length to Width ratio	1/10 min. ; 10/1 max.
R	Resistor overlap to terminal pad	0.002" min.
	Resistor underlap from pad	0.0005" min.
	Terminal pad size	0.004"x0.004" min.
	Resistor value per element	5Ω min.; 1kΩ max.
	Resistor sheet resistivity (ohms/sq)	10,25 50, 75, 100
	Resistor Tolerance	+/-15% Standard. +/-1% laser trimmed.
Air Bridge:		
U	Width	0.002" min.; 0.005" max.
W	Length between post	0.002" min.; 0.015" max
V	Contact Post size	0.0015" min. each side
S	Air bridge size at post	+0.0001" each side of contact post.
	Crossover insulation	Si ₃ N ₄ dielectric 3000A – 3500A
T	Crossover overlap	+0.0001" over conductor
	Bridge height/clearance	0.0004" nominal
Overlay Capacitor :		
	Dielectric	Si ₃ N ₄ 3000 – 3500A°
	Standard value (Tolerance +/-20%)	1.0 pF to 20pF
	Max capacitor per circuit	80pF
	Capacitance density	230pF/mm ² (0.15pF/mil ²)
	Breakdown voltage	25V (70V max)
	TCC	70ppm/°C
	Interconnect to other element	Air bridge
	Top plate size A	Per capacitance area
	Dielectric size	A+0.002" min. per side
	Bottom plate size	A+0.002" min. per side
Dicing / Cut out:		
	Dicing Tolerance	+/- 0.002" max.
	Cut out Tolerance	+/- 0.002" max.
X	Cut out to circuit clearance	0.002" min.
Y	Cut out radius	0.004" min.
	Cut out positioning	+/- 0.002"

MHMIC (MINIATURE HYBRID MICROWAVE IC)

This proprietary hybrid IC technology offers higher reliability compared to conventional hybrid circuits because of a reduction in number of bond wires and component attachments. At the same time, the RF performance is enhanced and fabrication costs reduced. The filled via technology together with chip-level active devices enables superior thermal management at the module level.

The following features can be integrated into MHMICs:

- Overlay Capacitors (MIM)
- Spiral Inductors
- Resistors
- Thick copper heat spreaders
- Lange Couplers with air-bridges
- Supported / non-supported (real) air-bridges
- Filled –planarized hermetic via holes
- Features down to 15 μm (line and space)

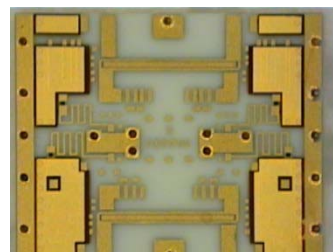

RF substrate with standard via holes to ground plane

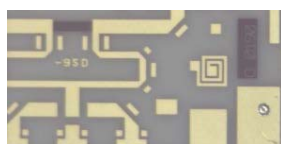
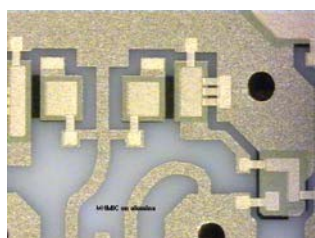

Details of MIM capacitors, resistors and air-bridges

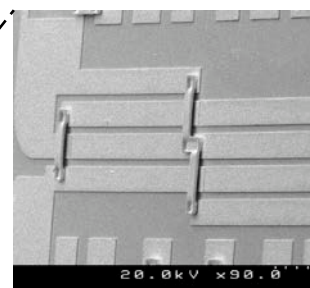
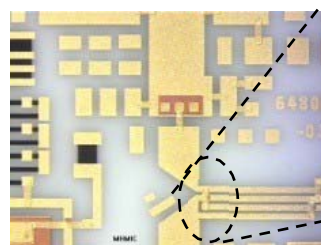

Details of Lange Coupler with printed air-bridges

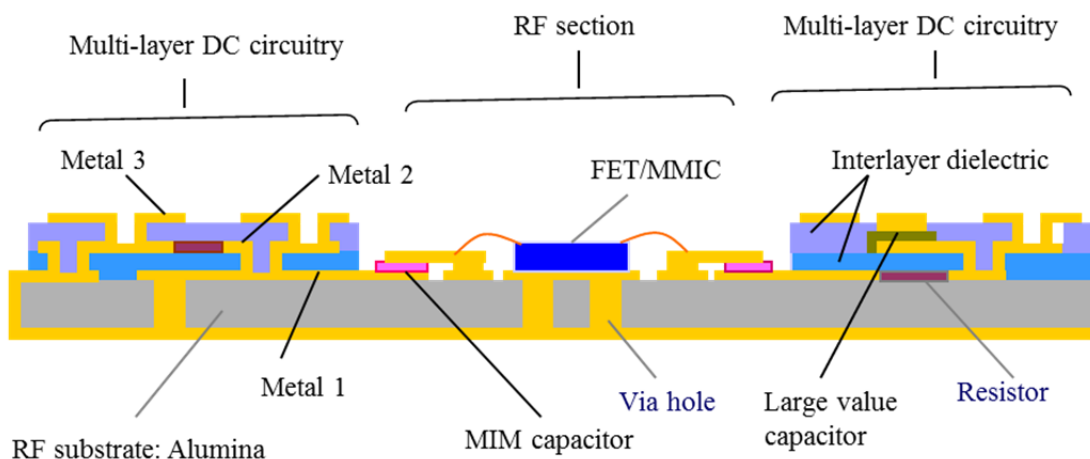

Cross sectional schematic of HMIC technology including filled vias

Spin-on layers of polyimide film allow for extremely compact modules with up to three (3) independent metal layers. Multi-layer thin-film also allows for high performance RF components, such as broadside couplers and modified Lange couplers.

HERMETIC SMD PACKAGES

Nanowave’s hermetic package technology allows the design and manufacturing of custom designed packaged ICs based on commercially available MMICs or discrete devices. The packages are available in hermetically sealed and non-hermetic versions. The filled via technology and cap attachment guarantee good hermetic closure on high performance thermal and electrical connections. The bottom side layout is customizable and comprises both, DC and RF pads.

KEY FEATURES

- Standard SMD attach process
- Light weight
- Excellent RF performance
- Customizable
- Hermetic / non-hermetic packages available
- Excellent approach for **Obsolescence Mitigation**

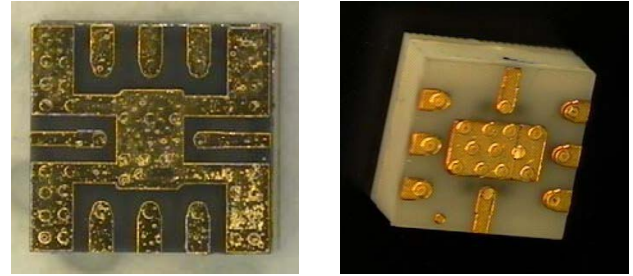

Two different bottom side contact layouts with capped and filled via holes.

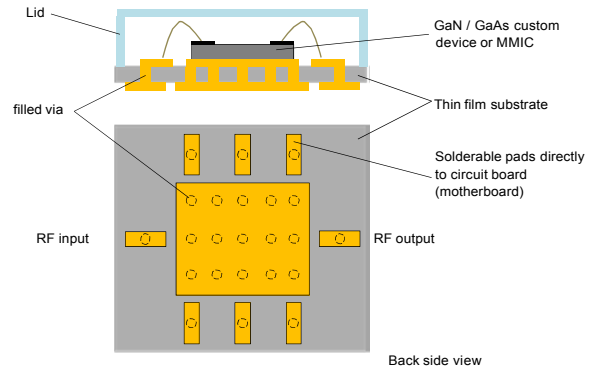

Schematic view on bottom side and cross section of SMD package.

PRELIMINARY TEST RESULTS

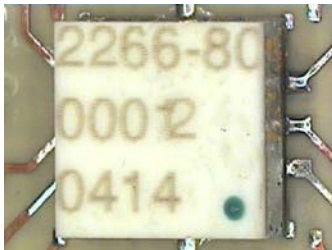

Photograph of soldered SMD broadband amplifier in SMD package

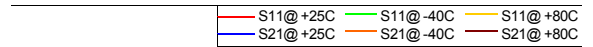

Serial # 2266-81-01
Input Return Loss vs Freq

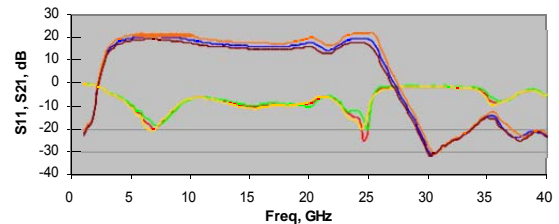

Test results of mounted SMD broadband amplifier 6 to 20 GHz

Model No	Ref. DIAG. #	Freq GHz	Gain / Ripple dB	NF dB	P1dB dBm	Vd / Id V / mA	Package Size Inch
NW1016-10SMD	6082266-66	10 - 16	15.0 ± 1.5	3.0	10	+4 / 75 (SS)	0.15 x 0.15 x 0.06
NW0620-18HSMD	6082266-81	6 - 20	17.0 ± 1.5	6.0	18	+4 / 200 (DS)	0.20 x 0.20 x 0.06

Notes:
 SS Single Supply
 SD Double Supply (see data sheet for detailed information.)

Further information and details are available on request. Please contact sales@nanowavetech.com.

SINGLE LAYER CERAMIC (SLC) CAPACITORS

Nanowave Technologies Inc. utilizes its vertically integrated thin film technologies to build Passive Microwave Components. Our Single Layer Ceramic (SLC) Capacitors use proprietary highly reliable thin film metallization. These SLCs are designed for automated wire and ribbon bonding, and are suitable for epoxy, AuSn or AgSn solder attach. Configuration can be either single element or multiple capacitors on a single chip in array form. In addition to catalog devices, Nanowave builds components to customer requirements.

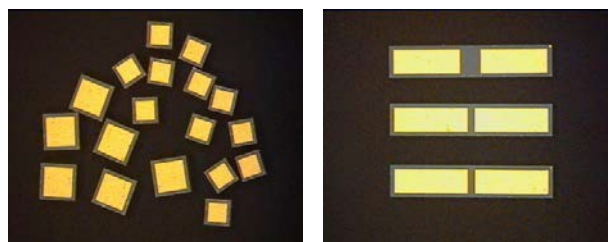

KEY FEATURES

- DC to 50 GHz
- Temperature Stable (+/-15%)
- Design for automatic pick and place
- High bond pull strength for ribbon and wire bonds (Exceeds MIL-STD-883)
- Low profile (0.004 in.) for high frequency DC blocks.
- Solder or epoxy attachable
- Border or non-border configuration
- 15 pF to 560 pF

APPLICATIONS

- MMIC packaging
- High Capacitance for By-Pass
- Hybrid Microelectronics
- High Frequency DC blocks

SPECIFICATION

Parameter	Units	Values
Capacitance	pF	15 to 560
Capacitance Tolerance	%	+/-10
Operating Temperature. Range	°C	-55 to +125
Temperature Coefficient	%	+/-15; +/-25
Rated Voltage	V	50
Construction		Single Layer Ceramic
Metallization		TiW/Ni/Au; TiW/Au
Dimension Tolerance		+/-0.002" L +/-0.003" W

QUALIFICATION TESTS

Test	Military Specification	Paragraph or Method	Result
Bond Strength	MIL-STD-883	2011	1 mil gold wire, >9 gm
Die Shear Strength	MIL-STD-883	2019	Exceeded
Thermal Shock	MIL-STD-202	107	Passed
Voltage Conditioning	MIL-C-49464	4.7.2	Passed
Dielectric Withstanding Voltage	MIL-STD-202	301	2.5X rated voltage
Insulation Resistance	MIL-STD-202	302	>1011 ohm
Low Voltage Humidity	MIL-C-49464	4.7.17	Passed
Life and Reliability	MIL-STD-883	1016	Passed

SINGLE LAYER CERAMIC (SLC) CAPACITORS

TEMPERATURE COEFFICIENT OF CAPACITANCE

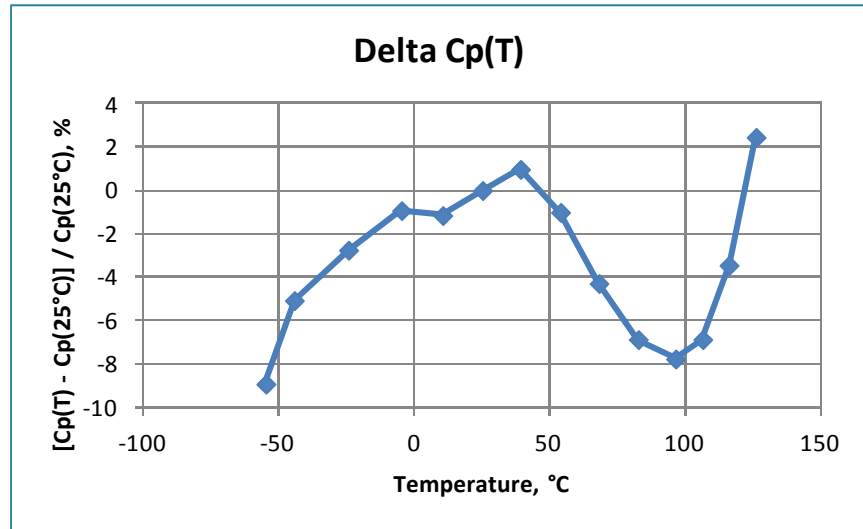

STANDARD CAPACITOR DIMENSIONAL INFORMATION

Capacitance (pF)	Size Code (L x W, mil)	Thickness (mil)
7.5	1515	6
12	1515	6
15	1515	6
18	1515	6
20	1515	6
22	1515	6
27	1515	6
33	1515	6
39	1515	6
47	2020	6
51	2020	6
56	2020	6
68	2020	6
75	2020	5
82	2020	5
100	2020	4
100	2525	6
120	2525	4
120	2525	5
150	2525	4
150	3030	6
180	3030	4
200	3030	4
220	3030	4
220	4040	6
270	3535	4
330	4040	4
390	4040	4
470	5050	4
560	5050	4
Array Capacitor		
2 x 150	110x20	6
2 x 150	80x20	5
3 x 120	110x20	5
4 x 120	120x20	4

SINGLE LAYER CERAMIC (SLC) CAPACITORS

CAPACITOR CONSTRUCTION

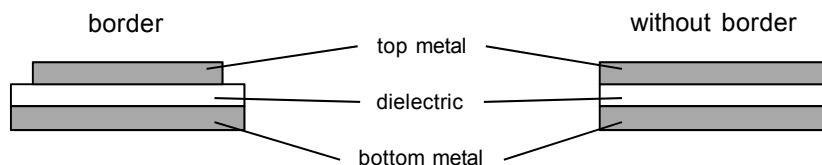
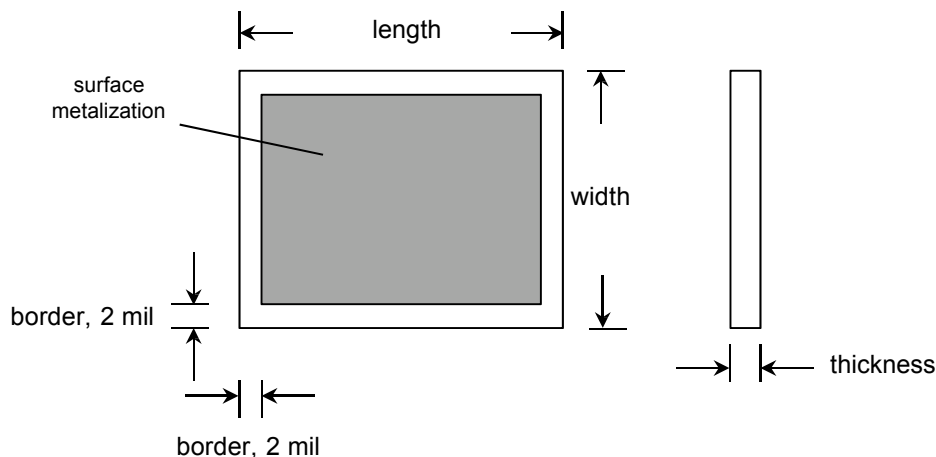

HOW TO ORDER

Example: 100pF SLC (SB1A100K04G50V20x20)

Type	No. of Elements	Dielectric Type	Value per Element	Tolerance	Thickness	Surface Metallization	Voltage	Length & Width
SB	1	A	100	K	04	G	50V	20X20

<p>Type: SB=Single layer Border SN=Single layer No Border</p> <p>No. of elements: 1=single 2=1x2 3=1x3 4=1x4</p> <p>Dielectric type: A : Temperature coefficient +/-15% (-55°C to +125°C) B : Temperature coefficient +/-25% (-55°C to +125°C)</p> <p>Value per Element: Capacitance per element in pF (3 number code).</p>	<p>Tolerance: Per EIA Standard G=+/-2% J=+/-5% K=+/-10% M=+/-20%</p> <p>Thickness: Dielectric thickness in Mils. (2 number code)</p> <p>Surface metallization : Top and Bottom metallization G=Ni/Au</p> <p>Rated Voltage: 16V, 50V</p> <p>Length & Width: External length dimension in Mils. (1st 2-3 numbers in code) External width dimension in Mils. (2nd 2-3 numbers in code)</p>
---	--

HIGH VALUE CHIP CAPACITORS

The chip capacitors offer excellent electrical (breakdown) and temperature stability, high reliability and a very large range of operating temperature. The main application for these capacitors can be found in high reliability RF circuits.

KEY FEATURES

- High-dielectric constant material
- Low loss
- High reliability
- Wire bondable
- Solder or epoxy attach
- In compliance with MIL-STD-883 and MIL-C-49464A

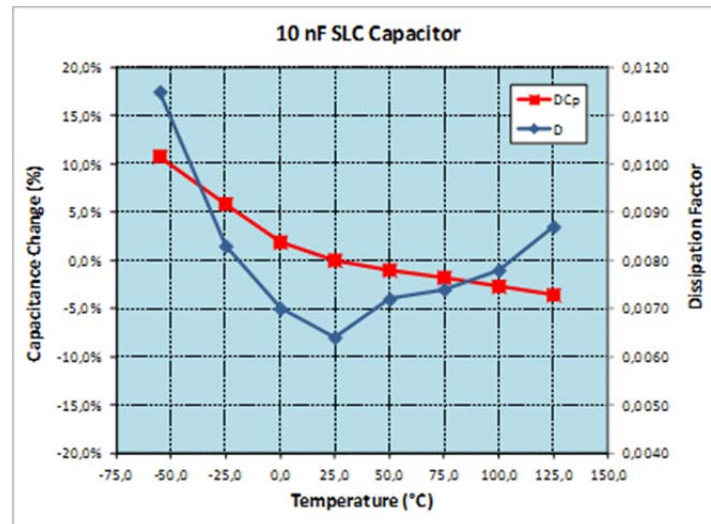
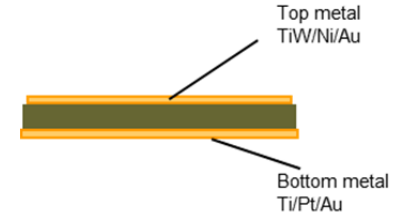
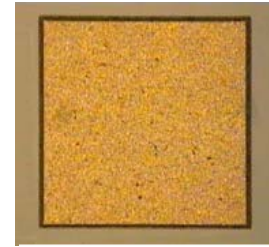

Temperature characteristics

ELECTRICAL SPECIFICATIONS

Parameter	Units	Values
Capacitance Range	nF	0.150 – 10.0
Temperature Coefficient $\Delta C/C$	%	± 15 ¹⁾
Rated Voltage	V	25
Breakdown Voltage	V	> 60
Insulation Resistance	Gohm	10.0
Dielectric loss		0.0025 @ 1 kHz and 1 MHz
Equivalent series resistance	mohm	100 @ 1 GHz
Operating Temperature Range	°C	-55 - +125
Size	inch	min: 0.012 x 0.012 max: 0.086 x 0.086
Thickness	inch	0.005

Full Data Sheet available on request.

MICROWAVE CHIP RESISTOR

KEY FEATURES

- High precision
- DC to 40 GHz
- Good wire and ribbon bondability
- Low TCR
- 2.5 ohm to 240Kohm

Microwave chip resistors are specially designed thin film resistors for use in high frequency RF matching and FET biasing. They are fabricated based on reactive sputtered Tantalum Nitride (TaN) thin film. Because of its self-passivating nature at elevated temperatures, Tantalum Nitride thin film resistors offer improved stability and improved performance at microwave frequencies. The technology is highly reliable, suitable for any commercial, military, and space application. Small size, tight tolerance control of the resistive layer and uniform deposition of the gold layers up to 200 micro-inches offer excellent wire bondability and exceptional microwave performance. The substrate materials are alumina, quartz, silicon, and aluminum nitride for high power applications.

APPLICATIONS

- Microwave hybrid microelectronics
- Drain and feedback resistors for high frequency RF matching
- D.C. biasing for microwave transistors.

SPECIFICATIONS

Electrical

Parameter		Value	Conditions
Power rating	mW	250 typical	MIL-R-55342A
Operating voltage	V	100 max	@ 25°C
Short time overload	$\Delta R/R$ %	+0.25	5x rated power, 5 sec, 25°C
Noise	dB	-30	MIL-STD-202 Method 308
Temp Cycling	$\Delta R/R$ %	+0.25	MIL-STD-202 Method 107F
Moisture Resistance	$\Delta R/R$ %	+0.25	MIL-STD-202 Method 106
Stability	$\Delta R/R$ %	+0.25	1000 hrs, rated power, 125°C
Temp Coefficient	ppm/°C	-100	-55°C to +125°C

Mechanical

Substrate	Alumina	AlN	Silicon	Quartz
	0.005" 0.010", 0.015"	0.010", 0.015"	0.010"	0.005"
Isolation layer	N/A	N/A	SiO ₂ , 10,000Å	N/A
Backing	TiW/Ni/Au	TiW/Ni/Au	Au, 3000Å min.	TiW/Ni/Au
Resistive film	TaN	TaN	TaN	TaN
Bond Pad	Au, 2.5 micron min.	Au, 2.5 micron min.	Au, 2.5 micron min.	Au, 2.5 micron min.
Bond Pad size	0.004" x 0.0025" min.	0.004" x 0.0025" min.	0.004" x 0.0025" min.	0.004" x 0.0025" min.

OUTLINE DRAWINGS

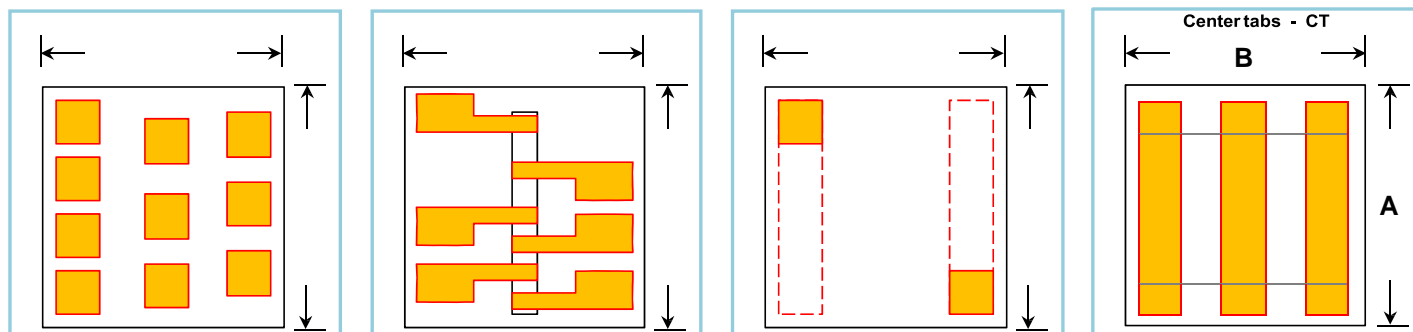

MICROWAVE CHIP RESISTOR

Size	Chip Style	Value (ohm)	Substrate material	Substrate thickness, in.
Microwave Resistors – MR				
0201	MS	400 (50,50,50,50,200)	A/Q	0.005, 0.010
0201	MS	280 (20,20,20,20,200)	A/Q	0.005, 0.010
0201	MS	60 (10,10,10,10,20)	A/Q	0.005, 0.010
0201	MS	50 (5,5,10,10,20)	A/Q	0.005, 0.010
0101	TT	10	A/Q	0.005, 0.010
0101	TT	20	A/Q	0.005, 0.010
0101	TT	30	A/Q	0.005, 0.010
0101	TT	40	A/Q	0.005, 0.010
0101	TT	50	A/Q	0.005, 0.010
0201	MS	85 (5,10,20,50)	A/Q	0.005, 0.010
0201	TT	2	A	0.005, 0.010
0201	TT	3	A	0.005, 0.010
0201	MS	62.5 (12.5,12.5,12.5,25)	A/Q	0.005, 0.010
0204	MS	240 (10,10,20,50,50,100)	A	0.010
DC resistors – CR				
0104	TT	1.5k	A	0.010
0303	MT	2.4k	S	0.010
0303	MT	24k	S	0.010
Custom	Custom	2 to 240k	Custom	0.010

CUSTOM GENERIC PART NUMBER DESIGNATION

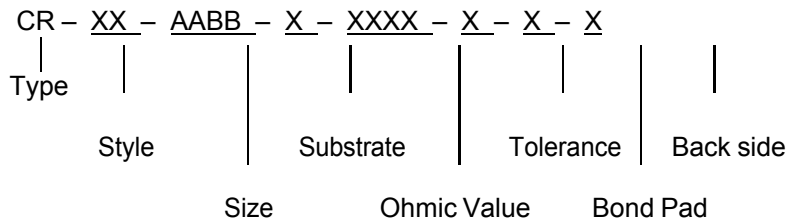

Type

MR	–	Microwave resistor
CR	–	DC biasing resistor

Style

TT	–	Two terminals
CT	–	Center tab
MT	–	Multi-tabs
MS	–	Multi-tabs side by side

Size AABB – 0201=0.020in.x0.010in.

Substrate

S	–	Silicon
A		Alumina
N		Aluminum nitride
Q		Quartz

Ohmic Value – 4-digit

1st 3 digits are significant with R as decimal point between 2nd and 3rd digits.
4th digit represents number of zeros to follow.
E.g. 1000 ohm (1001).

Tolerance

–	M = 20 %
K = 10 %	
J = 5 %	

Example

MR-MS-0201-Q-50R0-K-G-G
50 ohm multi side tabs microwave resistor

BROADBAND MEDIUM POWER THIN FILM ATTENUATOR

OVERVIEW

NANOWAVE provides a family of thin film attenuators for broadband and medium power applications up to 8 watts CW power. The Thin Film attenuators offer superior characteristics at frequencies up to 20GHz. These pads are constructed using AlN substrate material for high power handling. They are available in flange mount, surface mount, flip chip, and connectorized configurations.

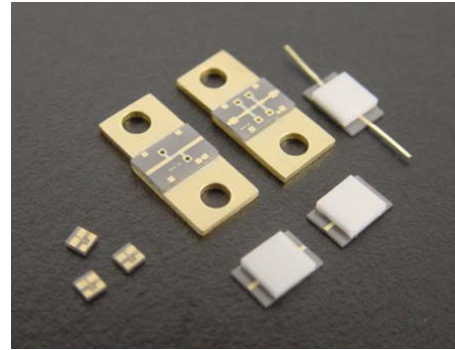

KEY FEATURES

- DC to 20GHz
- Low VSWR
- Temperature stable < -100ppm/°C
- High bond pull strength for ribbon and wire bonds (exceeds MIL-STD-883)
- Surface Mountable
- Flange Mountable using Copper or Copper Tungsten Flange with gold plated copper leads.
- High power handling capability.
- Standard values available from 1 to 20 dB

SPECIFICATION

Attenuation (dB)	Return Loss (dB) DC - 12 GHz	Return Loss (dB) 12 - 18 GHz	Tolerance (dB)
1	< -15	< -10	+/-0.1
3	< -15	< -10	+/-0.25
6	< -15	< -10	+/-0.25
10	< -15	< -10	+/-0.25
15	< -15	< -10	+/-0.25
20	< -15	< -10	+/-0.25

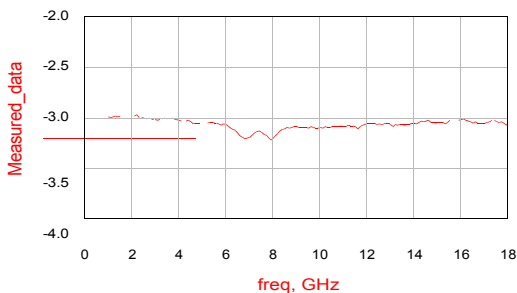

3 dB pad measured data

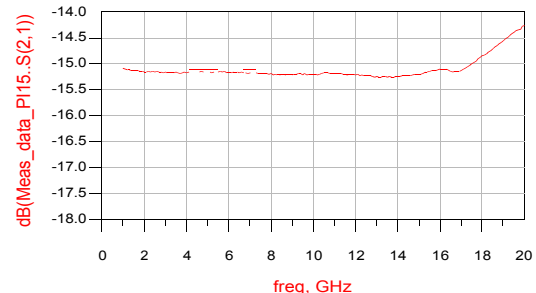

Pad 15 dB, measured data

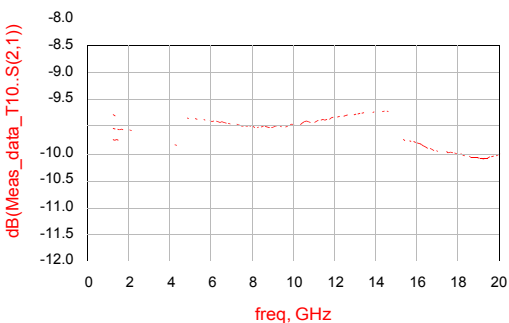

Pad 10 dB, measured data

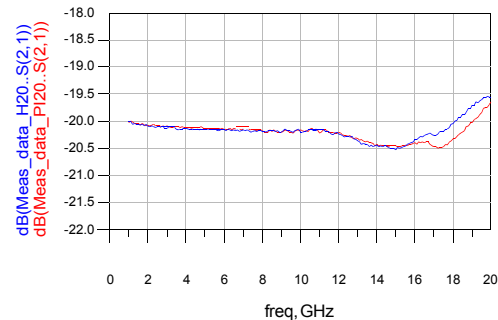

Pad 20 dB, measured data

BROADBAND MEDIUM POWER THIN FILM ATTENUATOR

Chip sizes for flip chip surface mount and hybrid assemblies are 1.4 mm x 1.4 mm (0.055 in. x 0.055 in.) for 1 W rated pads and 4.7mm x 3.0mm (.185 in. x .12 in.) for 5 W rated power. Flange mounted pads can handle 8 W minimum power.

Flange mount attenuators, DC-20GHz, 1-20dB

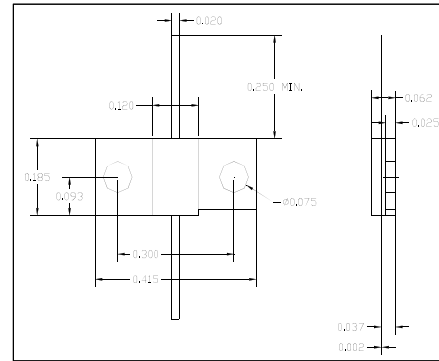
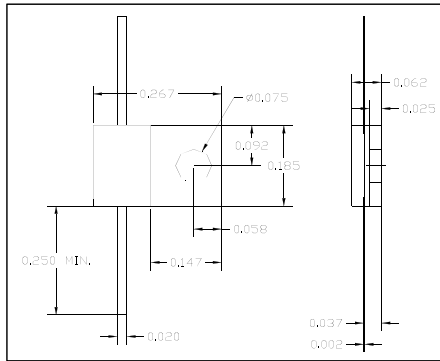

Dimensions
in inches

Chip attenuators, DC - 20GHz, 1 - 20dB

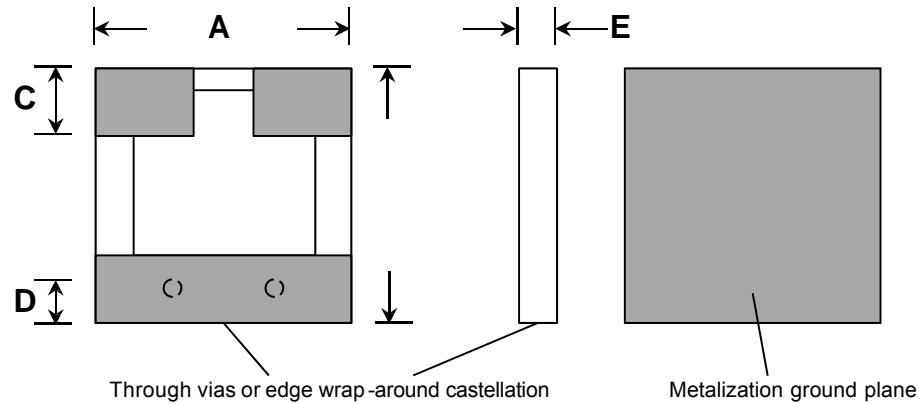

Attenuation (dB)	Dimension in mm (in.)					Size code	Package style
	A	B	C	D	E		
1-10	1.4 (0.055)	1.4 (0.055)	0.38 (.015)	0.25 (.010)	0.38 (.015)	01	Chip
12-20	2.7 (.105)	1.9 (0.075)	0.38 (.015)	0.25 (.010)	0.38 (.015)	02	Chip
1-20	4.7 (.185)	3.0 (.120)				03	Leaded
1-20	4.7 (.185)	10.5 (.415)				04	Flanged
1-20						05	Connectorized

HOW TO ORDER

Attenuators : **AT** **AT-DB-XX-YY**

XX – Package style :

- FL – Flange mount leaded
- LL – Leaded only
- WB – Wire bondable chips
- SF – Surface mount, flip chip
- SG – Surface mount on ground plane
- CN – Connectorized

DB – attenuation in dB

YY – Size code

Example: AT-03-SF-01

3dB pad, surface mount flip chip, .055" x .055"

Note: The specifications are subject to changes without notice.

THIN FILM FILTERS

NANOWAVE offers a variety of custom designed Thin-Film filter structures on Alumina, Aluminum Nitride, or high-dielectric constant material. The filters are manufactured according to MIL standards for an operating temperature range of -55°C to +85°C (or up to +125°C on request). All filter parameters are customizable.

Please ask for further details and information.



Planar 6-Pole Filter

40 dB rejection @ 9 kHz to 8.0 GHz and 10.5 to 16 GHz
Deviation from linear phase ± 3.0 deg

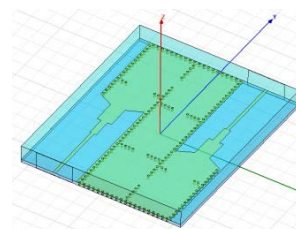

5-Pole SIW Filter

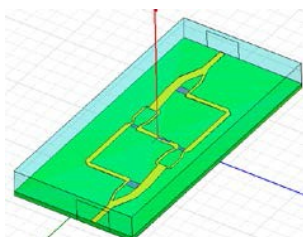

In-Line n-Way Combiner

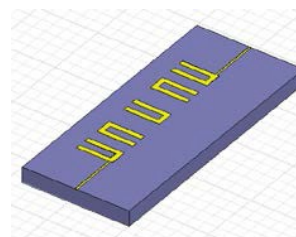

5-Pole HAIRPIN Filter

SPECIFICATION OF SAMPLE FILTERS

Filter Type	Frequency GHz	Insertion Loss dB	Ripple dB	Return Loss dB	Substrate Material	Size Inch
Planar 6-Pole	9.1 – 9.4	< 3.0	± 0.5	< -15.0	Al ₂ O ₃	
In-Line n-Way Combiner		0.75 ²⁾			Al ₂ O ₃	
5-Pole SIW	9.45 – 9.65	< 3.0 ¹⁾			Low-loss Al ₂ O ₃	-
5-Pole HAIRPIN	9.4 – 9.7	< 1.0			High-K	0.15 x 0.3

Notes:

1) @ 9.5 GHz

2) 3-way back-to-back measured insertion loss



ABOUT NANOWAVE

NANOWAVE Technologies Inc. was founded in 1992 and is a leading Canadian Designer and Manufacturer of Advanced Microwave and Millimeter Wave Components and Sub-Systems for the Radar, Defense, Communications, Industrial and Medical markets.

The company's products can be found on the most advanced commercial and defense aircraft, as well as ground based Radar and Communication Systems.

NANOWAVE's commitment to annual investments in R&D combined with in-house control of critical design, manufacturing and test processes results in rapid response to our customers' demands for:

- Customization
- Obsolescence Mitigation
- Demanding Technical Specifications
- On-time Delivery
- High Reliability
- Traceability



NANOWAVE Technologies Inc.
425 Horner Avenue
Etobicoke, Ontario M8W 4W3
Canada

Phone: +1-416-252-5602
Fax: +1-416-252-7077

sales@nanowavetech.com
www.nanowavetech.com

